

Einwegprinzip

Funktionsweise nach dem Prinzip der Einweglichtschranken. Zwei getrennte Sensorköpfe fungieren als Sender bzw. Empfänger. Die Reichweite ist abhängig vom verwendeten Verstärker.

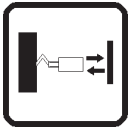

Taster

Funktionsweise nach dem Prinzip der Reflexionslichttaster. Sender und Empfänger sind als getrennte Faserbündel in einem Lichtleiter vereint. Die Tastweite ist abhängig vom verwendeten Verstärker.

Kabelmantel aus Silikon oder Metall

Typenschlüssel

Beispiel: LLK 2 030 S R B Q - 90 - 4,0 - 2,5

Lichtleitkabel

Funktionsprinzip

- 1 = 1-armig (Taster)
- 2 = 2-armig (Sender/Empfänger getrennt)

Kabellänge in cm

Ummantelung

- S = Silikon
- M = Metall

Lichtaustritt

- keine Angabe = axial
- R = radial

Besonderheiten

- B = biegsamer Sensorkopf

Ausführung Sensorkopf

- keine Angabe = zylindrisch
- Q = Quader

Biegung Sensorkopf

- keine Angabe = gerade
- 90 = 90° abgewinkelt (bei Quader: 90 = seitlicher Lichtaustritt)

Quader

- bei Quader: aktive Zone in mm

Zylinder

- bei Zylinder: Kopfdurchmesser in mm bzw. Gewindemaß M...

Ø Faserbündel in mm

Typenbeispiele



zylindrisch, glatt

Stufentastkopf, 3,5 mm / 5,6 mm glatte Hülse aus Edelstahl. Axialer Lichtaustritt. Verstärkeranschluss mittels Adaption M18. Einsetzbar von -40°C bis + 200°C.



zylindrisch, Gewinde

Sensorkopf mit Gewinde M6 aus Edelstahl. Axialer Lichtaustritt. Verstärkeranschluss mittels Adaption M18. Einsetzbar von -40°C bis + 200°C.



glatte Hülse, radiale Optik

Glatte Hülse, einseitig abgeflacht mit radialem Lichtaustritt. Länge 35 mm. Verstärkeranschluss mittels Adaption M18. Einsetzbar von -40°C bis + 200°C.

Einwegprinzip und Taster

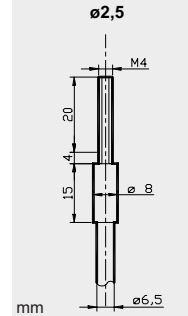
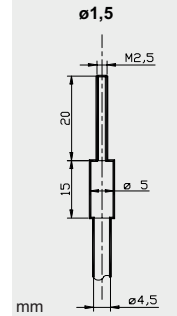
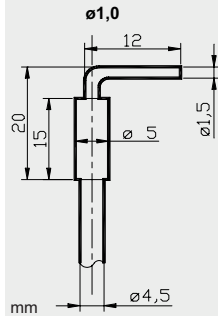
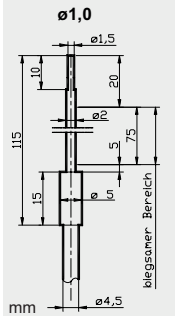
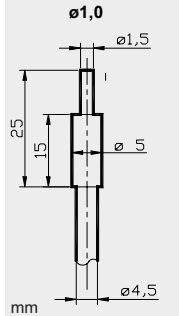
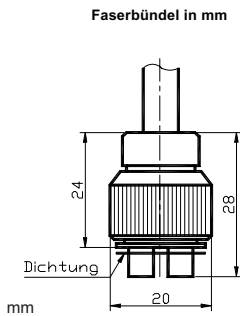

Taster

| | |
|-----------------------------------|---------------------------|
| Tastweite (1-armig) | |
| Ummantelung Länge / mm | |
| Silikon | 300 600 1000 |
| Metall | 300 600 1000 |
| fett gedruckt Vorzugstypen | |

| | | | | |
|--|--|--|--|--|
| 10mm | 10mm | 10mm | 25mm | 40mm |
| Typ | Typ | Typ | Typ | Typ |
| LLK1030S-1,5-1,0 LLK1060S-1,5-1,0 LLK1100S-1,5-1,0 LLK1030M-1,5-1,0 LLK1060M-1,5-1,0 LLK1100M-1,5-1,0 | LLK1030SB-2,0-1,0 LLK1060SB-2,0-1,0 LLK1100SB-2,0-1,0 LLK1030MB-2,0-1,0 LLK1060MB-2,0-1,0 LLK1100MB-2,0-1,0 | LLK1030S-90-1,5-1,0 LLK1060S-90-1,5-1,0 LLK1100S-90-1,5-1,0 LLK1030M-90-1,5-1,0 LLK1060M-90-1,5-1,0 LLK1100M-90-1,5-1,0 | LLK1030S-M2,5-1,5 LLK1060S-M2,5-1,5 LLK1100S-M2,5-1,5 LLK1030M-M2,5-1,5 LLK1060M-M2,5-1,5 LLK1100M-M2,5-1,5 | LLK1030S-M4-2,5 LLK1060S-M4-2,5 LLK1100S-M4-2,5 LLK1030M-M4-2,5 LLK1060M-M4-2,5 LLK1100M-M4-2,5 |

Einwegprinzip

| | |
|-----------------------------------|---------------------------|
| Reichweite (2-armig) | |
| Ummantelung Länge / mm | |
| Silikon | 300 600 1000 |
| Metall | 300 600 1000 |
| fett gedruckt Vorzugstypen | |

| | | | | |
|--|--|--|--|--|
| 120mm | 120mm | 120mm | 150mm | 600mm |
| Typ | Typ | Typ | Typ | Typ |
| LLK2030S-1,5-1,0 LLK2060S-1,5-1,0 LLK2100S-1,5-1,0 LLK2030M-1,5-1,0 LLK2060M-1,5-1,0 LLK2100M-1,5-1,0 | LLK2030SB-2,0-1,0 LLK2060SB-2,0-1,0 LLK2100SB-2,0-1,0 LLK2030MB-2,0-1,0 LLK2060MB-2,0-1,0 LLK2100MB-2,0-1,0 | LLK2030S-90-1,5-1,0 LLK2060S-90-1,5-1,0 LLK2100S-90-1,5-1,0 LLK2030M-90-1,5-1,0 LLK2060M-90-1,5-1,0 LLK2100M-90-1,5-1,0 | LLK2030S-M2,5-1,5 LLK2060S-M2,5-1,5 LLK2100S-M2,5-1,5 LLK2030M-M2,5-1,5 LLK2060M-M2,5-1,5 LLK2100M-M2,5-1,5 | LLK2030S-M4-2,5 LLK2060S-M4-2,5 LLK2100S-M4-2,5 LLK2030M-M4-2,5 LLK2060M-M4-2,5 LLK2100M-M4-2,5 |

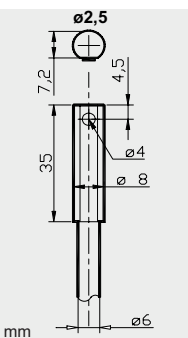
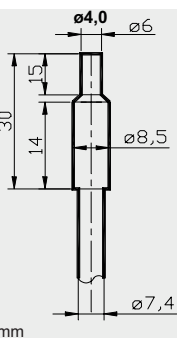
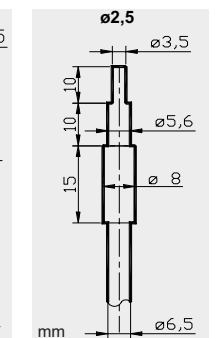
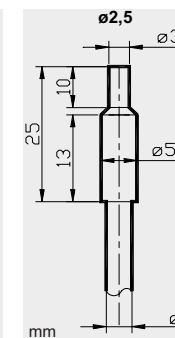
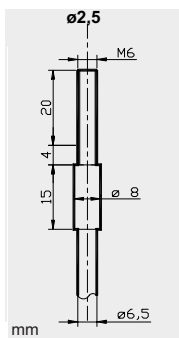
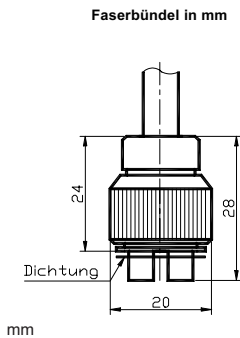

Taster

| | |
|-----------------------------------|---------------------------|
| Tastweite (1-armig) | |
| Ummantelung Länge / mm | |
| Silikon | 300 600 1000 |
| Metall | 300 600 1000 |
| fett gedruckt Vorzugstypen | |

| | | | | |
|--|--|--|--|--|
| 40mm | 40mm | 40mm | 80mm | 50mm |
| Typ | Typ | Typ | Typ | Typ |
| LLK1030S-M6-2,5 LLK1060S-M6-2,5 LLK1100S-M6-2,5 LLK1030M-M6-2,5 LLK1060M-M6-2,5 LLK1100M-M6-2,5 | LLK1030S-5,6-2,5 LLK1060S-5,6-2,5 LLK1100S-5,6-2,5 LLK1030M-5,6-2,5 LLK1060M-5,6-2,5 LLK1100M-5,6-2,5 | LLK1030S-8,0-2,5 LLK1060S-8,0-2,5 LLK1100S-8,0-2,5 LLK1030M-8,0-2,5 LLK1060M-8,0-2,5 LLK1100M-8,0-2,5 | LLK1030S-8,5-4,0 LLK1060S-8,5-4,0 LLK1100S-8,5-4,0 LLK1030M-8,5-4,0 LLK1060M-8,5-4,0 LLK1100M-8,5-4,0 | LLK1030SR-8,0-2,5 LLK1060SR-8,0-2,5 LLK1100SR-8,0-2,5 LLK1030MR-8,0-2,5 LLK1060MR-8,0-2,5 LLK1100MR-8,0-2,5 |

Einwegprinzip

| | |
|-----------------------------------|---------------------------|
| Reichweite (2-armig) | |
| Ummantelung Länge / mm | |
| Silikon | 300 600 1000 |
| Metall | 300 600 1000 |
| fett gedruckt Vorzugstypen | |

| | | | | |
|--|--|--|--|--|
| 800mm | 600mm | 600mm | 800mm | 500mm |
| Typ | Typ | Typ | Typ | Typ |
| LLK2030S-M6-2,5 LLK2060S-M6-2,5 LLK2100S-M6-2,5 LLK2030M-M6-2,5 LLK2060M-M6-2,5 LLK2100M-M6-2,5 | LLK2030S-5,6-2,5 LLK2060S-5,6-2,5 LLK2100S-5,6-2,5 LLK2030M-5,6-2,5 LLK2060M-5,6-2,5 LLK2100M-5,6-2,5 | LLK2030S-8,0-2,5 LLK2060S-8,0-2,5 LLK2100S-8,0-2,5 LLK2030M-8,0-2,5 LLK2060M-8,0-2,5 LLK2100M-8,0-2,5 | LLK2030S-8,5-4,0 LLK2060S-8,5-4,0 LLK2100S-8,5-4,0 LLK2030M-8,5-4,0 LLK2060M-8,5-4,0 LLK2100M-8,5-4,0 | LLK2030SR-8,0-2,5 LLK2060SR-8,0-2,5 LLK2100SR-8,0-2,5 LLK2030MR-8,0-2,5 LLK2060MR-8,0-2,5 LLK2100MR-8,0-2,5 |

* Sonderausführungen können auf Anfrage konfektioniert werden
* Passende Verstärkerbaureihe: OLK(T) 40...

Einwegprinzip und Taster

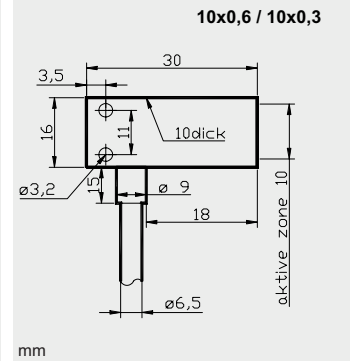

Taster

| | |
|----------------------------|------------|
| Tastweite (1-armig) | |
| Ummantelung Länge / mm | |
| Silikon | 300 |
| | 600 |
| | 1000 |
| Metall | 300 |
| | 600 |
| | 1000 |
| fett gedruckt Vorzugstypen | |

| |
|----------------------------|
| 40mm |
| Typ |
| LLK1030S-90-4,0-2,5 |
| LLK1060S-90-4,0-2,5 |
| LLK1100S-90-4,0-2,5 |
| LLK1030M-90-4,0-2,5 |
| LLK1060M-90-4,0-2,5 |
| LLK1100M-90-4,0-2,5 |

| |
|-------------------------|
| 80mm |
| Typ |
| LLK1030SQ-10-0,6 |
| LLK1060SQ-10-0,6 |
| LLK1100SQ-10-0,6 |
| LLK1030MQ-10-0,6 |
| LLK1060MQ-10-0,6 |
| LLK1100MQ-10-0,6 |

| |
|----------------------------|
| 80mm |
| Typ |
| LLK1030SQ-90-10-0,6 |
| LLK1060SQ-90-10-0,6 |
| LLK1100SQ-90-10-0,6 |
| LLK1030MQ-90-10-0,6 |
| LLK1060MQ-90-10-0,6 |
| LLK1100MQ-90-10-0,6 |

Einwegprinzip

| | |
|----------------------------|------------|
| Reichweite (2-armig) | |
| Ummantelung Länge / mm | |
| Silikon | 300 |
| | 600 |
| | 1000 |
| Metall | 300 |
| | 600 |
| | 1000 |
| fett gedruckt Vorzugstypen | |

| |
|----------------------------|
| 1000mm |
| Typ |
| LLK2030S-90-4,0-2,5 |
| LLK2060S-90-4,0-2,5 |
| LLK2100S-90-4,0-2,5 |
| LLK2030M-90-4,0-2,5 |
| LLK2060M-90-4,0-2,5 |
| LLK2100M-90-4,0-2,5 |

| |
|-------------------------|
| 800mm |
| Typ |
| LLK2030SQ-10-0,3 |
| LLK2060SQ-10-0,3 |
| LLK2100SQ-10-0,3 |
| LLK2030MQ-10-0,3 |
| LLK2060MQ-10-0,3 |
| LLK2100MQ-10-0,3 |

| |
|----------------------------|
| 800mm |
| Typ |
| LLK2030SQ-90-10-0,3 |
| LLK2060SQ-90-10-0,3 |
| LLK2100SQ-90-10-0,3 |
| LLK2030MQ-90-10-0,3 |
| LLK2060MQ-90-10-0,3 |
| LLK2100MQ-90-10-0,3 |

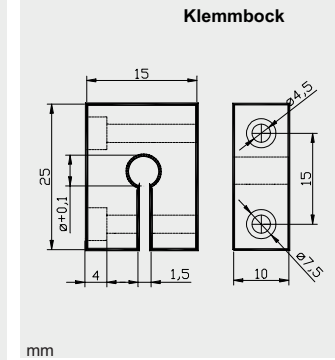
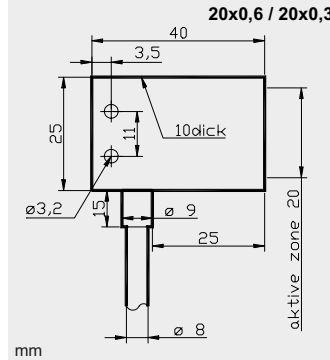
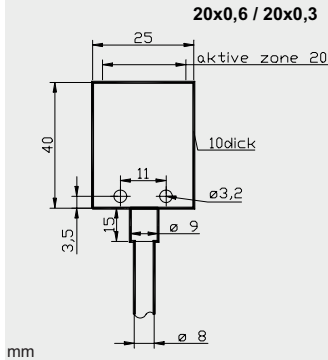

Taster

| | |
|----------------------------|------------|
| Tastweite (1-armig) | |
| Ummantelung Länge / mm | |
| Silikon | 300 |
| | 600 |
| | 1000 |
| Metall | 300 |
| | 600 |
| | 1000 |
| fett gedruckt Vorzugstypen | |

| |
|-------------------------|
| 100mm |
| Typ |
| LLK1030SQ-20-0,6 |
| LLK1060SQ-20-0,6 |
| LLK1100SQ-20-0,6 |
| LLK1030MQ-20-0,6 |
| LLK1060MQ-20-0,6 |
| LLK1100MQ-20-0,6 |

| |
|----------------------------|
| 100mm |
| Typ |
| LLK1030SQ-90-20-0,6 |
| LLK1060SQ-90-20-0,6 |
| LLK1100SQ-90-20-0,6 |
| LLK1030MQ-90-20-0,6 |
| LLK1060MQ-90-20-0,6 |
| LLK1100MQ-90-20-0,6 |

| | |
|----------------|-------|
| ø in mm | |
| Typ | |
| 3,5mm | KLB35 |
| 5,0mm | KLB50 |
| 5,6mm | KLB56 |
| 6,5mm | KLB65 |
| 8,0mm | KLB80 |
| 8,5mm | KLB85 |

Einwegprinzip

| | |
|----------------------------|------------|
| Reichweite (2-armig) | |
| Ummantelung Länge / mm | |
| Silikon | 300 |
| | 600 |
| | 1000 |
| Metall | 300 |
| | 600 |
| | 1000 |
| fett gedruckt Vorzugstypen | |

| |
|-------------------------|
| 1000mm |
| Typ |
| LLK2030SQ-20-0,3 |
| LLK2060SQ-20-0,3 |
| LLK2100SQ-20-0,3 |
| LLK2030MQ-20-0,3 |
| LLK2060MQ-20-0,3 |
| LLK2100MQ-20-0,3 |

| |
|----------------------------|
| 1000mm |
| Typ |
| LLK2030SQ-90-20-0,3 |
| LLK2060SQ-90-20-0,3 |
| LLK2100SQ-90-20-0,3 |
| LLK2030MQ-90-20-0,3 |
| LLK2060MQ-90-20-0,3 |
| LLK2100MQ-90-20-0,3 |